



MC33263

Ultra Low Noise 150 mA Low Dropout Voltage Regulator with ON/OFF Control

Housed in a SOT23-L package, the MC33263 delivers up to 150 mA where it exhibits a typical 180 mV dropout. With an incredible noise level of 25 μ V_{RMS} (over 100 Hz to 100 kHz, with a 10 nF bypass capacitor), the MC33263 represents the ideal choice for sensitive circuits, especially in portable applications where noise performance and space are premium. The MC33263 also excels in response time and reacts in less than 25 μ s when receiving an OFF to ON signal (with no bypass capacitor).

Thanks to a novel concept, the MC33263 accepts output capacitors without any restrictions regarding their Equivalent Series Resistance (ESR) thus offering an obvious versatility for immediate implementation.

With a typical DC ripple rejection better than -90 dB (-70 dB @ 1 kHz), it naturally shields the downstream electronics against choppy power lines.

Additionally, thermal shutdown and short-circuit protection provide the final product with a high degree of ruggedness.

Features:

- Very Low Quiescent Current 170 μ A (ON, no load), 100 nA (OFF, no load)
- Very Low Dropout Voltage, typical value is 137 mV at an output current of 100 mA
- Very Low Noise with external bypass capacitor (10 nF), typically 25 μ V_{rms} over 100 Hz to 100 kHz
- Internal Thermal Shutdown
- Extremely Tight Line Regulation typically -90 dB
- Ripple Rejection -70 dB @ 1 kHz
- Line Transient Response: 1 mV for $\Delta V_{in} = 3$ V
- Extremely Tight Load Regulation, typically 20 mV at $\Delta I_{out} = 150$ mA
- Multiple Output Voltages Available
- Logic Level ON/OFF Control (TTL-CMOS Compatible)
- ESR can vary from 0 to 3 Ω
- Functionally and Pin Compatible with TK112xxA/B Series

Applications:

- All Portable Systems, Battery Powered Systems, Cellular Telephones, Radio Control Systems, Toys and Low Voltage Systems

ULTRA LOW NOISE 150 mA LOW DROPOUT VOLTAGE REGULATOR WITH ON/OFF CONTROL

SILICON MONOLITHIC
INTEGRATED CIRCUIT

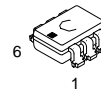

NW SUFFIX
PLASTIC PACKAGE
CASE 318J-01
(SOT-23L)

PIN CONNECTIONS

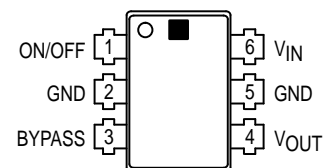

(Top View)

MC33263 Block Diagram

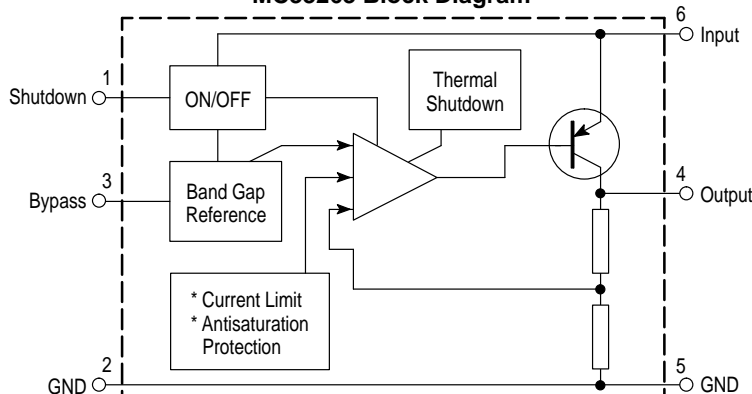

ORDERING INFORMATION

Device	Version	Operating Ambient Temperature Range
MC33263NW-28R2	2.8 V	T _A = -40° to +85°C
MC33263NW-30R2	3.0 V	
MC33263NW-32R2	3.2 V	
MC33263NW-33R2	3.3 V	
MC33263NW-38R2	3.8 V	
MC33263NW-40R2	4.0 V	
MC33263NW-47R2	4.75 V	
MC33263NW-50R2	5.0 V	

All Devices Available in SOT-23L 6 Lead Package

MC33263

MAXIMUM RATINGS

Rating	Pin #	Symbol	Value	Unit
Power Supply Voltage	6	V_{in}	12	V
Power Dissipation and Thermal Resistance		P_D	Internally Limited	W
Maximum Power Dissipation		$R_{\theta JA}$	210	$^{\circ}C/W$
NW Suffix, Plastic Package		$R_{\theta JC}$		$^{\circ}C/W$
Thermal Resistance, Junction-to-Air		T_A	-40 to +85	$^{\circ}C$
Thermal Resistance, Junction-to-Case		T_{Jmax}	150	$^{\circ}C$
Operating Ambient Temperature		T_{stg}	-60 to +150	$^{\circ}C$
Maximum Junction Temperature				
Storage Temperature Range				

DEVICE MARKING

XALYW	Marking	Version
1st Digit	A	2.8 V
	B	3.0 V
	C	3.2 V
	D	3.3 V
	E	3.8 V
	F	4.0 V
	G	4.75 V
	H	5.0 V
2nd Digit	A	Location Code
3rd Digit	L	Wafer Lot Traceability
4th/5th Digits	YW	Date Code

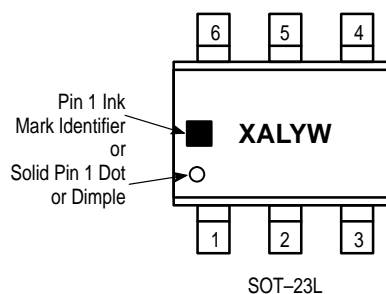

ELECTRICAL CHARACTERISTICS (For typical values $T_A = 25^{\circ}C$, for min/max values $T_A = -40^{\circ}C$ to $+85^{\circ}C$, Max $T_J = 150^{\circ}C$)

Characteristics	Pin #	Symbol	Min	Typ	Max	Unit
-----------------	-------	--------	-----	-----	-----	------

CONTROL ELECTRICAL CHARACTERISTICS

Input Voltage Range	1	$V_{ON/OFF}$	0	-	V_{in}	V
ON/OFF Input Current (All versions) $V_{ON/OFF} = 2.4$ V	1	$I_{ON/OFF}$	-	2.5	-	μA
ON/OFF Input Voltages (All versions) Logic "0", i.e. OFF State Logic "1", i.e. ON State	1	$V_{ON/OFF}$	- 2.2	- -	0.3 -	V

CURRENTS PARAMETERS

Current Consumption in OFF State (All versions) OFF Mode Current: $V_{in} = V_{out} + 1.0$ V, $I_{out} = 0$ mA		I_{QOFF}	-	0.1	2.0	μA
Current Consumption in ON State (All versions) ON Mode Sat Current: $V_{in} = V_{out} + 1.0$ V, $I_{out} = 0$ mA		I_{QON}	-	170	200	μA
Current Consumption in Saturation ON State (All versions) ON Mode Sat Current: $V_{in} = V_{out} - 0.5$ V, $I_{out} = 0$ mA		I_{QSAT}	-	900	1400	μA
Current Limit $V_{in} = V_{out} + 1.0$ V, (All versions) Output Short-circuited (Note 1)		I_{MAX}	175	210	-	mA

Note 1. I_{out} (Output Current) is the measured current when the output voltage drops below 0.3 V with respect to V_{out} at $I_{out} = 30$ mA.

MC33263

ELECTRICAL CHARACTERISTICS (For typical values $T_A = 25^\circ\text{C}$, for min/max values $T_A = -40^\circ\text{C}$ to $+85^\circ\text{C}$, Max $T_J = 150^\circ\text{C}$)

Characteristics	Pin #	Symbol	Min	Typ	Max	Unit
$V_{in} = V_{out} + 1.0\text{ V}$, $T_A = 25^\circ\text{C}$, $1.0\text{ mA} < I_{out} < 150\text{ mA}$ 2.8 Suffix 3.0 Suffix 3.2 Suffix 3.3 Suffix 3.8 Suffix 4.0 Suffix 4.75 Suffix 5.0 Suffix	4	V_{out}	2.74 2.94 3.13 3.23 3.72 3.92 4.66 4.90	2.8 3.0 3.2 3.3 3.8 4.0 4.75 5.0	2.86 3.06 3.27 3.37 3.88 4.08 4.85 5.1	V
$V_{in} = V_{out} + 1.0\text{ V}$, $-40^\circ\text{C} < T_A < 80^\circ\text{C}$, $1.0\text{ mA} < I_{out} < 150\text{ mA}$ 2.8 Suffix 3.0 Suffix 3.2 Suffix 3.3 Suffix 3.8 Suffix 4.0 Suffix 4.75 Suffix 5.0 Suffix	4	V_{out}	2.7 2.9 3.09 3.18 3.67 3.86 4.58 4.83	2.8 3.0 3.2 3.3 3.8 4.0 4.75 5.0	2.9 3.1 3.31 3.42 3.93 4.14 4.92 5.17	V

LINE AND LOAD REGULATION, DROPOUT VOLTAGES

Line Regulation (All versions) $V_{out} + 1.0\text{ V} < V_{in} < 12\text{ V}$, $I_{out} = 60\text{ mA}$	4/6	Regline	–	2.0	10	mV
Load Regulation (All versions) $V_{in} = V_{out} + 1.0\text{ V}$ $I_{out} = 1.0$ to 60 mA $I_{out} = 1.0$ to 100 mA $I_{out} = 1.0$ to 150 mA	1	Regload	– – –	8.0 15 20	25 35 45	mV
Dropout Voltage (All versions) $I_{out} = 10\text{ mA}$ $I_{out} = 100\text{ mA}$ $I_{out} = 150\text{ mA}$	4, 6	$V_{in} - V_{out}$	– – –	30 137 180	90 230 260	mV

DYNAMIC PARAMETERS

Ripple Rejection (All versions) $V_{in} = V_{out} + 1.0\text{ V}$, $V_{pp} = 1.0\text{ V}$, $f = 1.0\text{ kHz}$, $I_{out} = 60\text{ mA}$	4, 6		60	70	–	dB
Line Transient Response $V_{in} = V_{out} + 1.0\text{ V}$ to $V_{out} + 4.0\text{ V}$, $I_{out} = 60\text{ mA}$, $d(V_{in})/dt = 15\text{ mV}/\mu\text{s}$	4, 6		–	1.0	–	mV
Output Noise Voltage (All versions) $C_{out} = 1.0\text{ }\mu\text{F}$, $I_{out} = 60\text{ mA}$, $f = 100\text{ Hz}$ to 100 kHz $C_{bypass} = 10\text{ nF}$ $C_{bypass} = 1.0\text{ nF}$ $C_{bypass} = 0\text{ nF}$	4, 6	V_{RMS}	– – –	25 40 65	– – –	μV_{rms}
Output Noise Density $C_{out} = 1.0\text{ }\mu\text{F}$, $I_{out} = 60\text{ mA}$, $f = 1.0\text{ kHz}$	4	V_N	–	230	–	$\text{nV}/\sqrt{\text{Hz}}$
Output Rise Time (All versions) $C_{out} = 1.0\text{ }\mu\text{F}$, $I_{out} = 30\text{ mA}$, $V_{ON/OFF} = 0$ to 2.4 V 1% of ON/OFF Signal to 99% of Nominal Output Voltage Without Bypass Capacitor With $C_{bypass} = 10\text{ nF}$	4	t_r	– –	40 1.1	– –	μs ms

THERMAL SHUTDOWN

Thermal Shutdown (All versions)			–	150	–	$^\circ\text{C}$
---------------------------------	--	--	---	-----	---	------------------

DEFINITIONS

Load Regulation – The change in output voltage for a change in load current at constant chip temperature.

Dropout Voltage – The input/output differential at which the regulator output no longer maintains regulation against further reductions in input voltage. Measured when the output drops 100 mV below its nominal value (which is measured at 1.0 V differential), dropout voltage is affected by junction temperature, load current and minimum input supply requirements.

Output Noise Voltage – The RMS AC voltage at the output with a constant load and no input ripple, measured over a specified frequency range.

Maximum Power Dissipation – The maximum total dissipation for which the regulator will operate within specifications.

Quiescent Current – Current which is used to operate the regulator chip and is not delivered to the load.

Line Regulation – The change in input voltage for a change in the input voltage. The measurement is made under conditions of low dissipation or by using pulse techniques such that the average chip temperature is not significantly affected.

Line Transient Response – Typical over- and undershoot response when input voltage is excited with a given slope.

Thermal Protection – Internal thermal shutdown circuitry is provided to protect the integrated circuit in the event that the maximum junction temperature is exceeded. When activated, typically 150°C, the regulator turns off. This feature is provided to prevent catastrophic failures from accidental overheating.

Maximum Package Power Dissipation – The maximum package power dissipation is the power dissipation level at which the junction temperature reaches its maximum value i.e. 125°C. The junction temperature is rising while the difference between the input power ($V_{CC} \times I_{CC}$) and the output power ($V_{out} \times I_{out}$) is increasing.

Depending on ambient temperature, it is possible to calculate the maximum power dissipation, maximum load current or maximum input voltage (see Application Hints: Protection).

The maximum power dissipation supported by the device is a lot increased when using appropriate application design. Mounting pad configuration on the PCB, the board material and also the ambient temperature are affected the rate of temperature rise. It means that when the IC has good thermal conductivity through PCB, the junction temperature will be “low” even if the power dissipation is great.

The thermal resistance of the whole circuit can be evaluated by deliberately activating the thermal shutdown of the circuit (by increasing the output current or raising the input voltage for example).

Then you can calculate the power dissipation by subtracting the output power from the input power. All variables are then well known: power dissipation, thermal shutdown temperature (150°C for MC33263) and ambient temperature.

APPLICATION HINTS

Input Decoupling – As with any regulator, it is necessary to reduce the dynamic impedance of the supply rail that feeds the component. A 1 μ F capacitor either ceramic or tantalum is recommended and should be connected close to the MC33263 package. Higher values will correspondingly improve the overall line transient response.

Output Decoupling – Thanks to a novel concept, the MC33263 is a stable component and does not require any Equivalent Series Resistance (ESR) neither a minimum output current. Capacitors exhibiting ESRs ranging from a few m Ω up to 3 Ω can thus safely be used. The minimum decoupling value is 1 μ F and can be augmented to fulfill stringent load transient requirements. The regulator accepts ceramic chip capacitors as well as tantalum devices.

Noise Performances – Unlike other LDOs, the MC33263 is a true low-noise regulator. With a 10 nF bypass capacitor, it typically reaches the incredible level of 25 μ V_{RMS} overall noise between 100 Hz and 100 kHz. To give maximum insight on noise specifications, MOTOROLA includes spectral density graphics as well as noise dependency versus bypass capacitor.

The bypass capacitor impacts the start-up phase of the MC33263 as depicted by the data-sheet curves. A typical 1 ms settling time is achieved with a 10 nF bypass capacitor. However, thanks to its low-noise architecture, the MC33263 can operate without bypass and thus offers a typical 20 μ s start-up phase. In that case, the typical output noise stays lower than 65 μ V_{RMS} between 100 Hz – 100 kHz.

Protections – The MC33263 hosts several protections, conferring natural ruggedness and reliability to the products implementing the component. The output current is internally limited to a minimum of 175 mA while temperature shutdown occurs if the die heats up beyond 150°C. These value lets you assess the maximum differential voltage the device can sustain at a given output current before its protections come into play.

The maximum dissipation the package can handle is given by:

$$P_{max} = \frac{T_{Jmax} - T_A}{R_{\theta JA}}$$

If T_{Jmax} is internally limited to 150°C, then the MC33263 can dissipate up to 595 mW @ 25°C.

The power dissipated by the MC33263 can be calculated from the following formula:

$$P_{tot} = \langle V_{in} \cdot I_{gnd}(I_{out}) \rangle + \langle V_{in} - V_{out} \rangle \cdot I_{out}$$

or

$$V_{in_{max}} = \frac{P_{tot} + V_{out} \cdot I_{out}}{I_{gnd} + I_{out}}$$

If a 150 mA output current is needed, the ground current is extracted from the data-sheet curves: 6.5 mA @ 150 mA. For a MC33263NW28R2 (2.8 V), the maximum input voltage will then be 6.48 V, a rather comfortable margin.

MC33263

Typical Application – The following figure portrays the typical application for the MC33263 where both input/output decoupling capacitors appear.

Figure 1. A Typical MC33263 Application with Recommended Capacitor Values

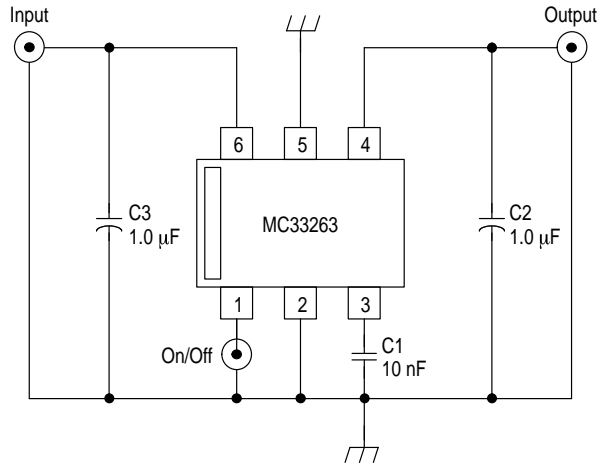

As for any low noise designs, particular care has to be taken when tackling Printed Circuit Board (PCB) layout. The figure below gives an example of a layout where stray inductances/capacitances are minimized.

Figure 2. Printed Circuit Board

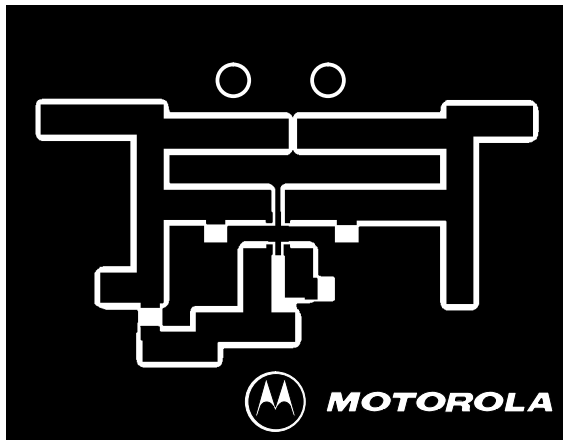
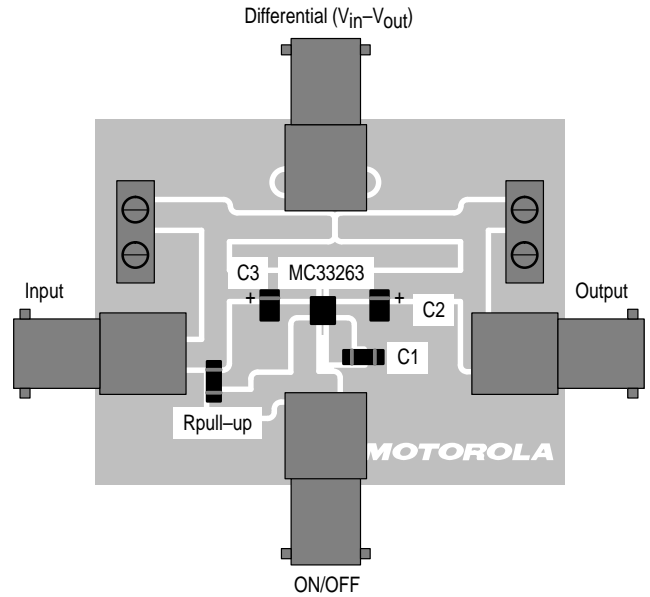

Figure 3. Copper Side Component Layout



This layout is the basis for an MC33263 performance evaluation board where the BNC connectors give the user an easy and quick evaluation mean.

MC33263

MC33263 Wake-up Improvement – In portable applications, an immediate response to an enable signal is vital. If noise is not of concern, the MC33263 without a bypass capacitor settles in nearly 20 μs and typically delivers 65 μVRMS between 100 Hz and 100 kHz.

In ultra low-noise systems, the designer needs a 10 nF bypass capacitor to decrease the noise down to 25 μVRMS between 100 Hz and 100 kHz. With the adjunction of the 10 nF capacitor, the wake-up time expands up to 1 ms as shown on the data-sheet curves. If an immediate response is wanted, following figure's circuit gives a solution to charge the bypass capacitor with the enable signal without degrading the noise response of the MC33263.

At power-on, C4 is discharged. When the control logic sends its wake-up signal by going to a high level, the PNP base is momentarily tight to ground. The PNP switch closes and immediately charges the bypass capacitor C1 toward its operating value. After a few μs , the PNP opens and becomes totally transparent to the regulator.

This circuit improves the response time of the regulator which drops from 1 ms down to 30 μs . The value of C4 needs to be tweaked in order to avoid any bypass capacitor overload during the wake-up transient.

Figure 4. A PNP Transistor Drives the Bypass Pin when Enable Goes High

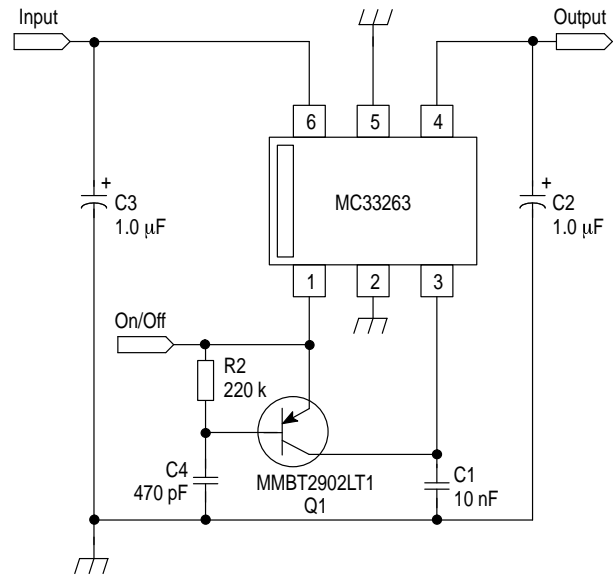
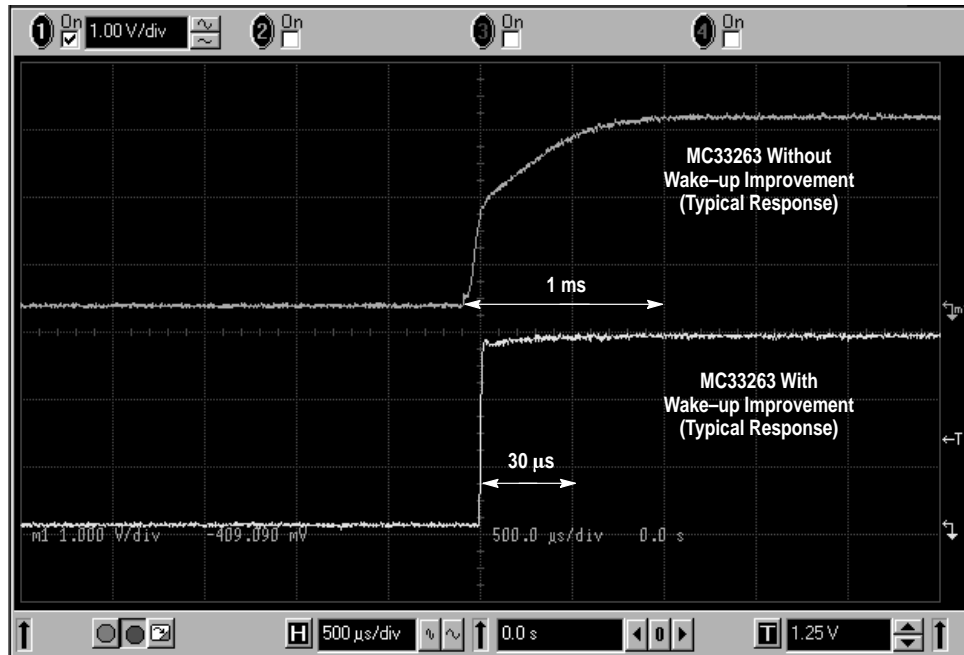

Figure 5. MC33263 Wake-up Improvement with Small PNP Transistor



MC33263

The PNP being wired upon the bypass pin, it shall not degrade the noise response of the MC33263. Figure 6 confirms the good behavior of the integrated circuit in this

area which reaches a typical noise level of 26 μ VRMS (100 Hz to 100 kHz) at $I_{out} = 60$ mA.

Figure 6. Noise Density of the MC33263 with a 10 nF Bypass Capacitor and a Wake-up Improvement Network

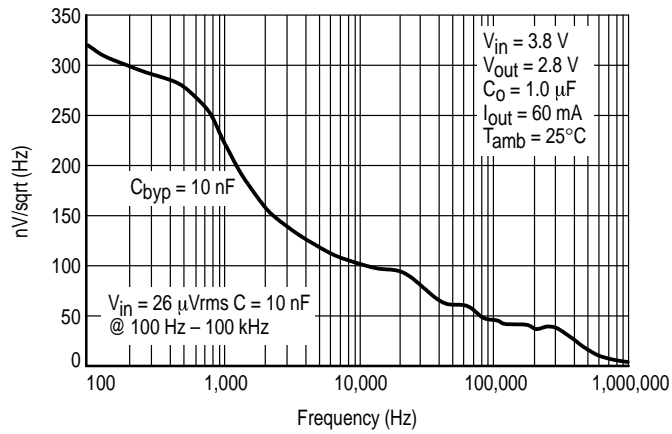

TYPICAL PERFORMANCES CHARACTERISTICS

Ground Current Performances

Figure 1. Ground Current versus Output Current

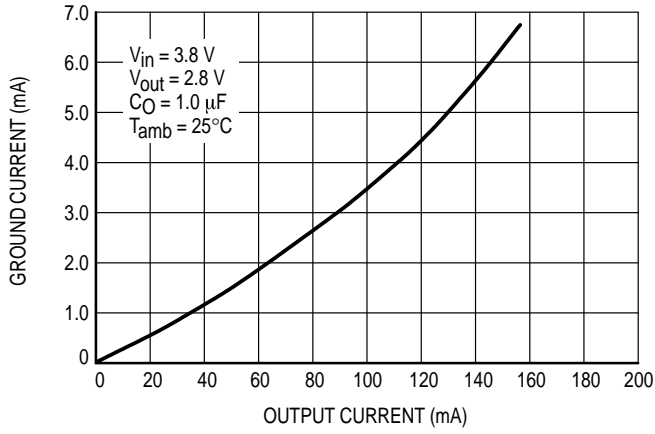
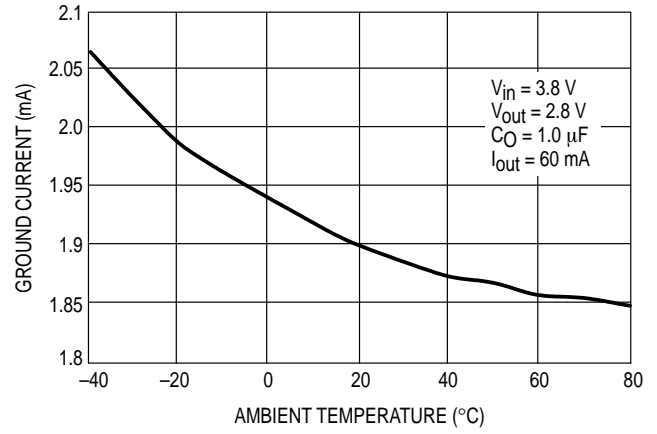

Figure 2. Ground Current versus Ambient Temperature



TYPICAL PERFORMANCES CHARACTERISTICS

Line Transient Response and Output Voltage

Figure 3. Quiescent Current versus Temperature

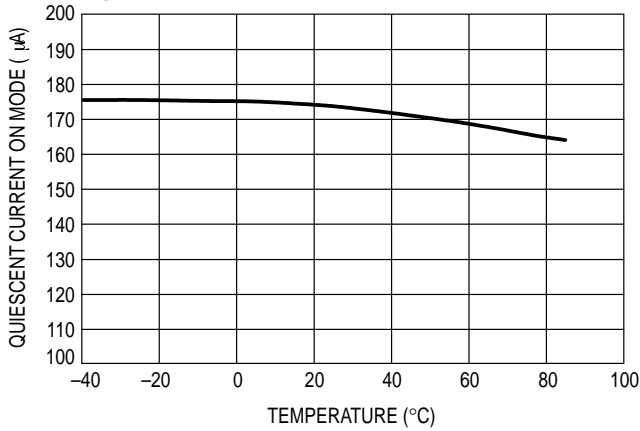
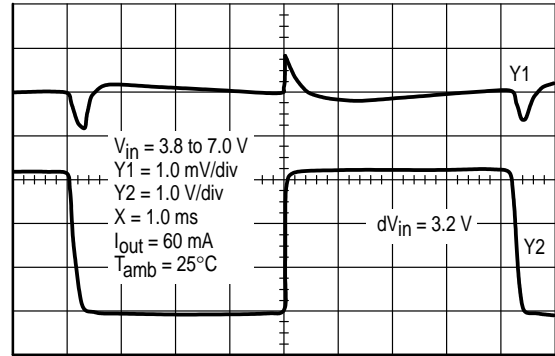
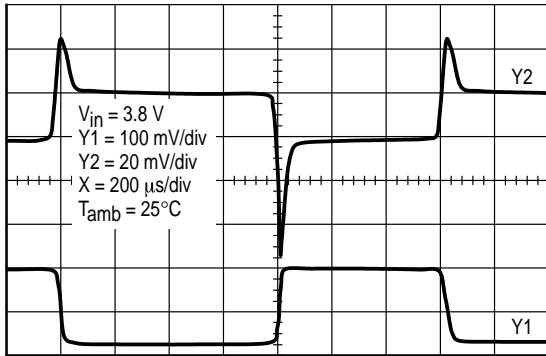

Figure 4. Line Transient Response



Load Transient Response versus Load Current Slope

Figure 5. $I_{out} = 3.0 \text{ mA to } 150 \text{ mA}$



Y1: OUTPUT CURRENT, Y2: OUTPUT VOLTAGE

Figure 6. $I_{Slope} = 100 \text{ mA}/\mu\text{s}$ (Large Scale)
 $I_{out} = 3.0 \text{ mA to } 150 \text{ mA}$

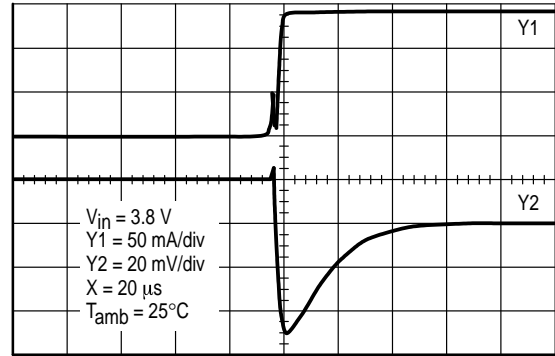

Y1: OUTPUT CURRENT, Y2: OUTPUT VOLTAGE

Figure 7. $I_{Slope} = 6.0 \text{ mA}/\mu\text{s}$ (Large Scale)
 $I_{out} = 3.0 \text{ mA to } 150 \text{ mA}$

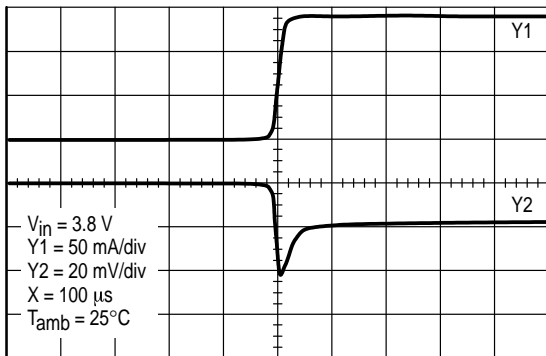

Y1: OUTPUT CURRENT, Y2: OUTPUT VOLTAGE

Figure 8. $I_{Slope} = 2.0 \text{ mA}/\mu\text{s}$ (Large Scale)
 $I_{out} = 3.0 \text{ mA to } 150 \text{ mA}$

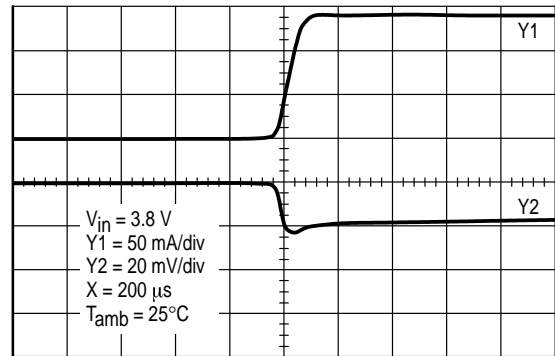

Y1: OUTPUT CURRENT, Y2: OUTPUT VOLTAGE

TYPICAL PERFORMANCES CHARACTERISTICS

Noise Performances

Figure 9. Noise Density versus Bypass Capacitor

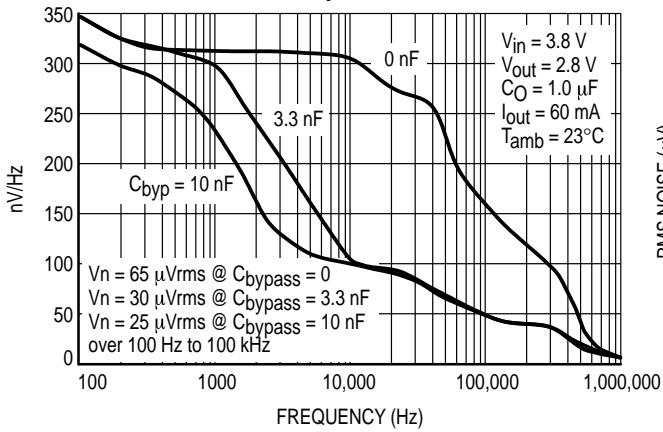
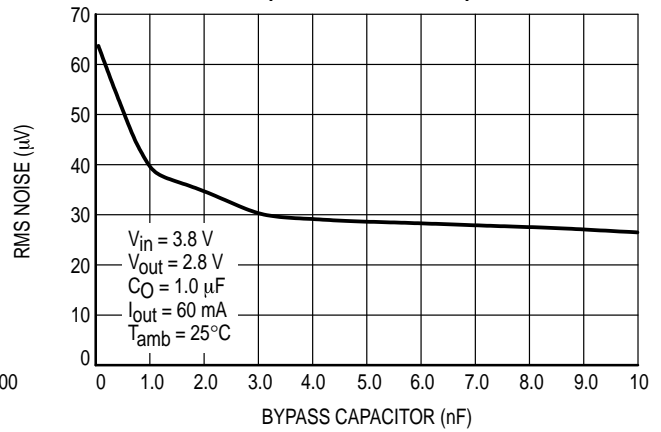

Figure 10. RMS Noise versus Bypass Capacitor (100 Hz – 100 kHz)



Settling Time Performances

Figure 11. Output Voltage Settling Time versus Bypass Capacitor

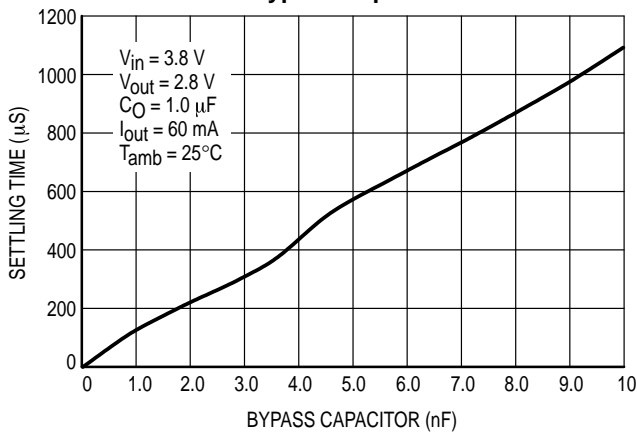

Figure 12. Output Voltage Settling Shape Cbypass = 10 nF

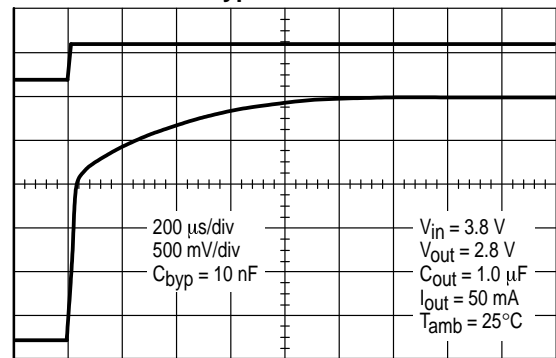

Figure 13. Output Voltage Settling Shape Cbypass = 3.3 nF

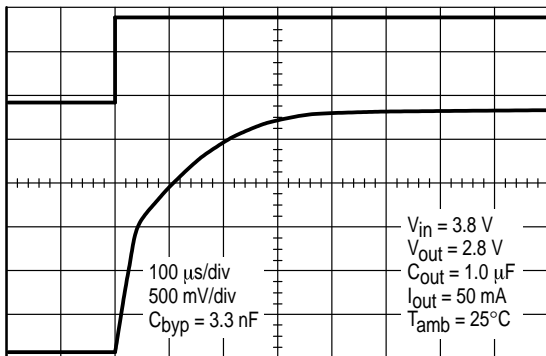
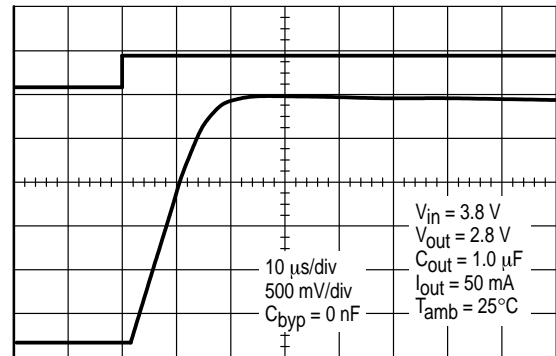

Figure 14. Output Voltage Settling Shape without Bypass Capacitor



TYPICAL PERFORMANCES CHARACTERISTICS

Dropout Voltage

Figure 15. Dropout Voltage versus I_{out}

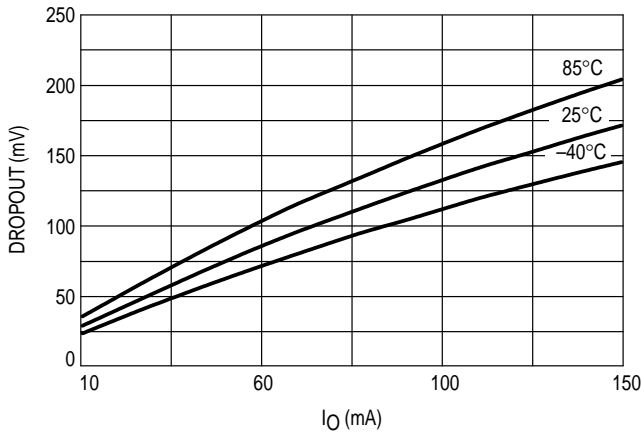
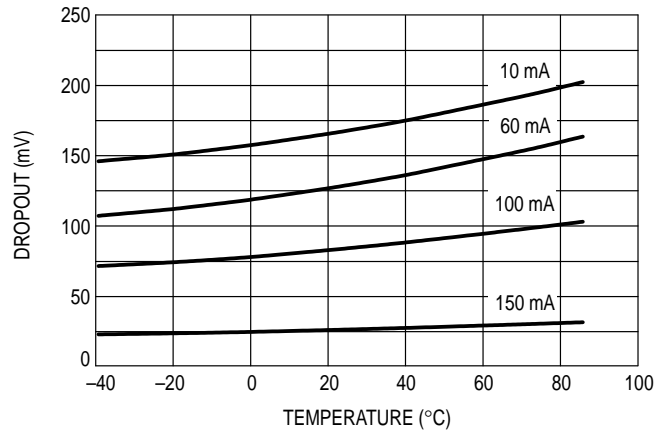

Figure 16. Dropout Voltage versus Temperature



Output Voltage

Figure 17. Output Voltage versus Temperature

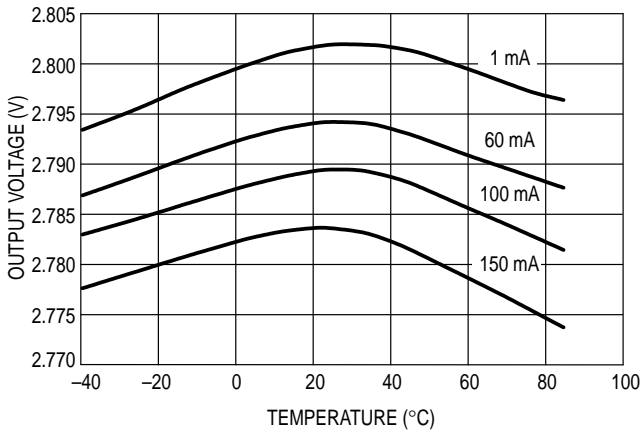
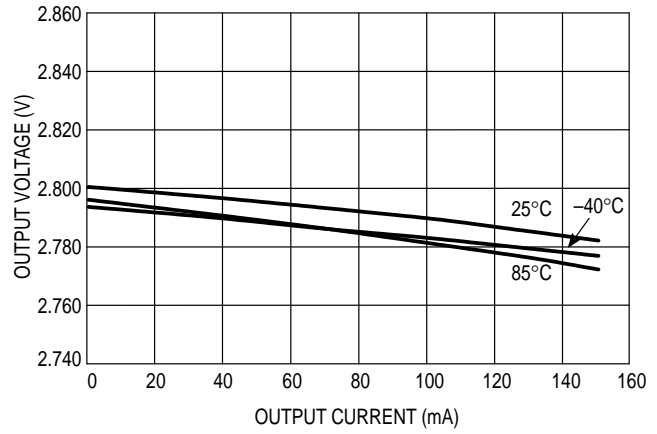

Figure 18. Output Voltage versus I_{out}



Ripple Rejection Performances

Figure 19. Ripple Rejection versus Frequency with 10 nF Bypass Capacitor

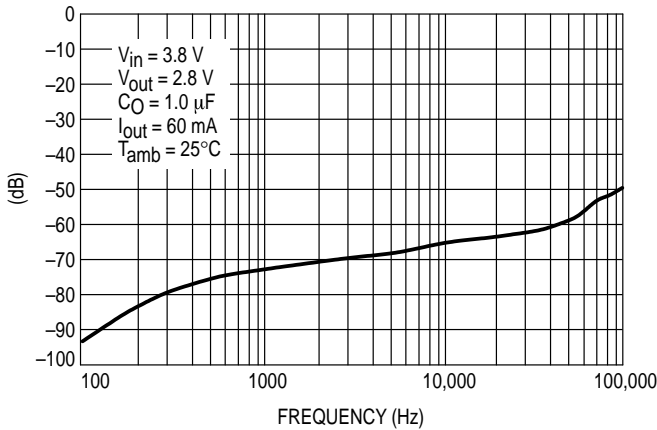
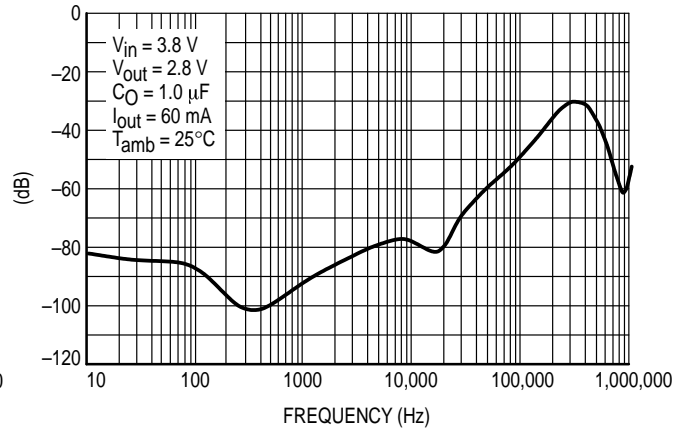

Figure 20. Ripple Rejection versus Frequency without Bypass Capacitor



MC33263

OUTLINE DIMENSIONS

NW SUFFIX
PLASTIC PACKAGE
CASE 318J-01
(SOT-23L)
ISSUE O

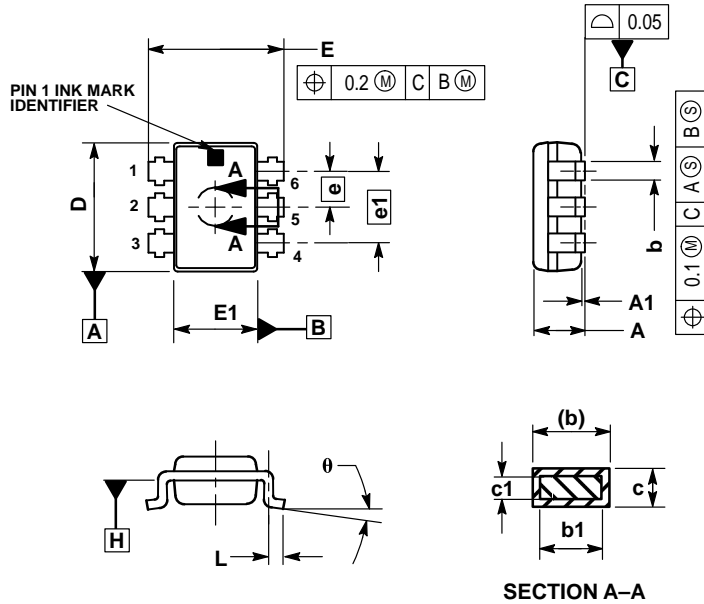

NOTES:

1. DIMENSIONS ARE IN MILLIMETERS.
2. INTERPRET DIMENSIONS AND TOLERANCES PER ASME Y14.5M, 1994.
3. DIMENSION E1 DOES NOT INCLUDE INTERLEAD FLASH OR PROTRUSION. INTERLEAD FLASH OR PROTRUSION SHALL NOT EXCEED 0.23 PER SIDE.
4. DIMENSIONS b AND b2 DO NOT INCLUDE DAMBAR PROTRUSION. ALLOWABLE DAMBAR PROTRUSION SHALL BE 0.08 TOTAL IN EXCESS OF THE b AND b2 DIMENSIONS AT MAXIMUM MATERIAL CONDITION.
5. TERMINAL NUMBERS ARE SHOWN FOR REFERENCE ONLY.
6. DIMENSIONS D AND E1 ARE TO BE DETERMINED AT DATUM PLANE H.

D	MILLIMETERS	
	MIN	MAX
A	1.25	1.40
A1	0.00	0.10
b	0.35	0.50
b1	0.35	0.45
c	0.10	0.25
c1	0.10	0.20
D	3.20	3.60
E	3.00	3.60
E1	2.00	2.40
e	[0.95]	
e1	[1.90]	
L	0.25	0.55
θ	0° - 10°	

Motorola reserves the right to make changes without further notice to any products herein. Motorola makes no warranty, representation or guarantee regarding the suitability of its products for any particular purpose, nor does Motorola assume any liability arising out of the application or use of any product or circuit, and specifically disclaims any and all liability, including without limitation consequential or incidental damages. "Typical" parameters which may be provided in Motorola data sheets and/or specifications can and do vary in different applications and actual performance may vary over time. All operating parameters, including "Typicals" must be validated for each customer application by customer's technical experts. Motorola does not convey any license under its patent rights nor the rights of others. Motorola products are not designed, intended, or authorized for use as components in systems intended for surgical implant into the body, or other applications intended to support or sustain life, or for any other application in which the failure of the Motorola product could create a situation where personal injury or death may occur. Should Buyer purchase or use Motorola products for any such unintended or unauthorized application, Buyer shall indemnify and hold Motorola and its officers, employees, subsidiaries, affiliates, and distributors harmless against all claims, costs, damages, and expenses, and reasonable attorney fees arising out of, directly or indirectly, any claim of personal injury or death associated with such unintended or unauthorized use, even if such claim alleges that Motorola was negligent regarding the design or manufacture of the part. Motorola and are registered trademarks of Motorola, Inc. Motorola, Inc. is an Equal Opportunity/Affirmative Action Employer.

Mfax is a trademark of Motorola, Inc.

How to reach us:

USA/EUROPE/Locations Not Listed: Motorola Literature Distribution;
P.O. Box 5405, Denver, Colorado 80217. 1-303-675-2140 or 1-800-441-2447

JAPAN: Motorola Japan Ltd.; SPD, Strategic Planning Office, 141,
4-32-1 Nishi-Gotanda, Shinagawa-ku, Tokyo, Japan. 81-3-5487-8488

Customer Focus Center: 1-800-521-6274

Mfax™: RMFAX0@email.sps.mot.com - TOUCHTONE 1-602-244-6609
Motorola Fax Back System - US & Canada ONLY 1-800-774-1848
- http://sps.motorola.com/mfax/

ASIA/PACIFIC: Motorola Semiconductors H.K. Ltd.; 8B Tai Ping Industrial Park,
51 Ting Kok Road, Tai Po, N.T., Hong Kong. 852-26629298

HOME PAGE: <http://motorola.com/sps/>

